

SCULPDOT



Designer : Voxdale

Versatile spotlight for accent and architectural lighting

Designed to enhance architectural detail, sculptures and other features, the SCULPDOT is a useful tool for a careful lighting design, especially in combination with SCULPFLOOD luminaires.

Compact and elegant, the SCULPDOT is designed with no visible screws on the front of the frame to maintain the aesthetics.

SCULPDOT offers different colour and lighting options to help designers deliver their desired results. Eye-catching dynamic lighting scenarios can be controlled via the DMX-RDM protocol.



IP 66

IK 08

IK 06

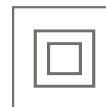

Concept

SCULPDOT is composed of a die-cast aluminium body and a protector in tempered glass or polycarbonate.

Thanks to an external refractor, the beam can be easily adapted on-site. The refractor can mimic the soft-edged light distribution of a HID solution. In addition, the associated bracket offers a degree angle indication system allowing for precise adjustment. All these features ease the fine-tuning of the installation for an optimal final result.

For more installation flexibility and to satisfy specific constraints (high ambient temperature for example), the driver and the power supply can be installed remotely.



SCULPDOT is available with monochromatic, RGBW and tunable white LEDs.



Thanks to an external refractor, the beam can be easily adapted on-site.

TYPES OF APPLICATION

- ACCENT & ARCHITECTURAL
- BRIDGES

KEY ADVANTAGES

- Precise on-site photometric distribution via external refractor
- Wide range of operating temperatures
- Connections can be made without the need for stripping or special tools
- Inclination angle indicated on bracket

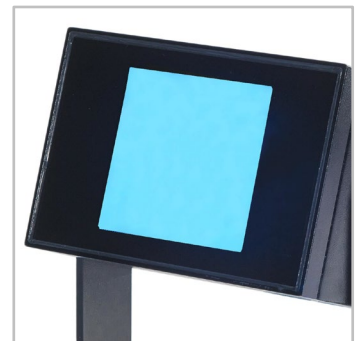

For dynamic lighting scenarios, SCULPDOT can be controlled with DMX or DALI protocols.



SCULPDOT is proposed with an internal driver.

GENERAL INFORMATION

CE mark	Yes
ROHS compliant	Yes
French law of December 27th 2018 - Compliant with application type(s)	a, b, c, d, e, f, g
Testing standard	LM 79-08 (all measurements in ISO17025 accredited laboratory)

HOUSING AND FINISH

Housing	Aluminium
Optic	Polycarbonate
Protector	Tempered glass Polycarbonate
Housing finish	Polyester powder coating
Standard colour(s)	AKZO grey 900 sanded
Tightness level	IP 66
Impact resistance	IK 06, IK 08

· Any other RAL or AKZO colour upon request

· IK may be different according to the size/configurations. Please consult us.

ELECTRICAL INFORMATION

Electrical class	Class I EU, Class II EU
Nominal voltage	220-240V – 50-60Hz
Power factor (at full load)	0.9
Surge protection options (kV)	10
Electromagnetic compatibility (EMC)	EN 55015 / EN 61000-4-5
Control protocol(s)	DALI, DMX-RDM
Control options	Custom dimming profile, Remote management
Associated control system(s)	Nicolaudie Pharos

OPTICAL INFORMATION

LED colour temperature	RGB CW 3000K (Warm White 830) 4000K (Neutral White 840)
Colour rendering index (CRI)	>80 (Warm White 830) >80 (Neutral White 840)

LIFETIME OF THE LEDS @ TQ 25°C

All configurations	100,000h - L79
--------------------	----------------

DIMENSIONS AND MOUNTING

AxBxC (mm inch)	160x240x199 6.3x9.4x7.8
Weight (kg lbs)	7 15.4
Aerodynamic resistance (CxS)	0.05
Mounting possibilities	Bracket enabling adjustable inclination

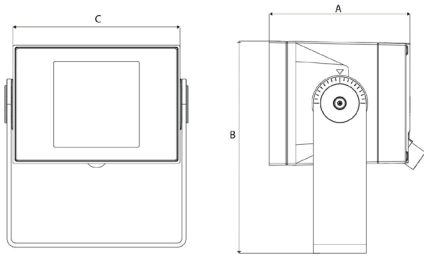

SCULPDOT | U-shaped stirrup adjustable bracket

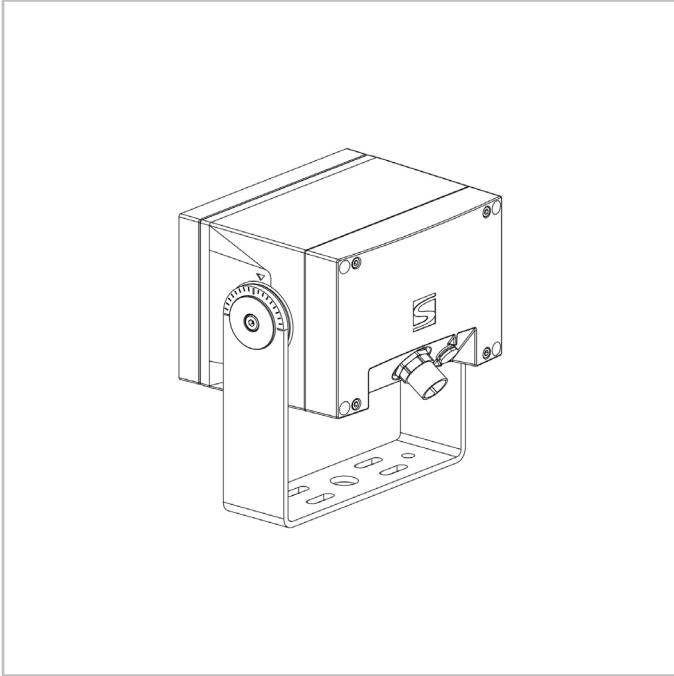



Luminaire	Number of LEDs	Current (mA)	Luminaire output flux (lm) Warm White 830		Luminaire output flux (lm) Neutral White 840		Luminaire output flux (lm) RGB CW		Power consumption (W)		Luminaire efficacy (lm/W) Up to
			Min	Max	Min	Max	Min	Max	Min	Max	
SCULPDOT	16	350	-	-	-	-	800	1300	21	21	62
	16	600	1400	2700	1500	2900	-	-	35	35	83
	16	810	1700	3500	1900	3700	-	-	44.5	44.5	83

Tolerance on LED flux is $\pm 7\%$ and on total luminaire power $\pm 5\%$

5124 - Narrow Beam, No diffuser

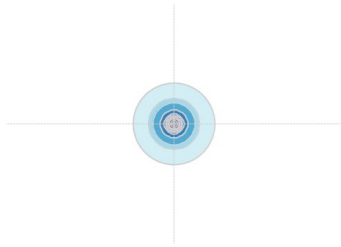
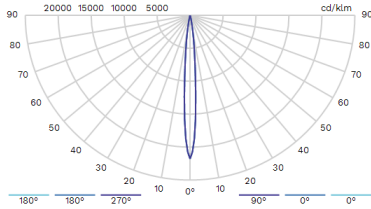

6275 - Circular Beam

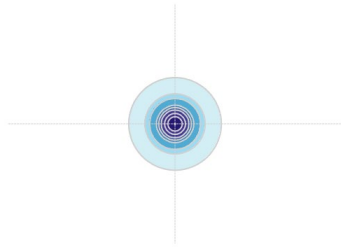
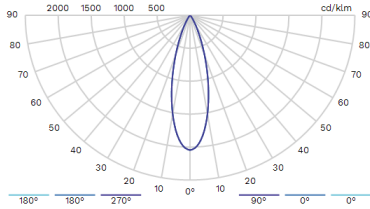

6276 - Circular Beam

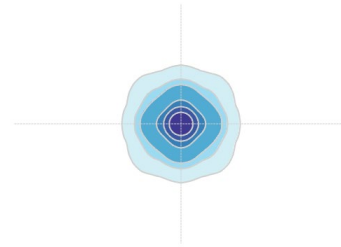
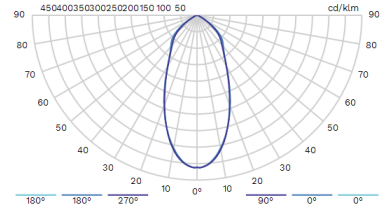

6277 RGB+CW (all ON 100%)
Elliptical, Horizontal Beam

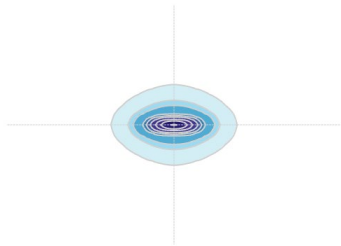
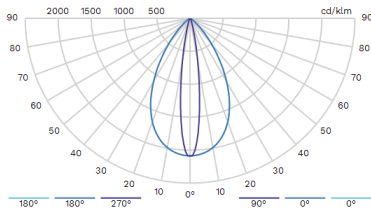

6278 - Elliptical, Horizontal Beam

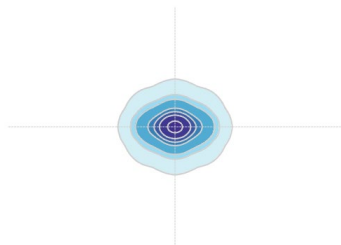
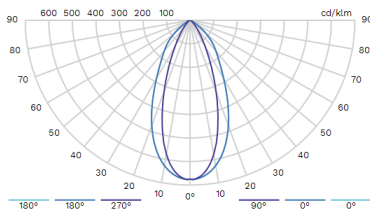

6297 - Elliptical, Horizontal Beam

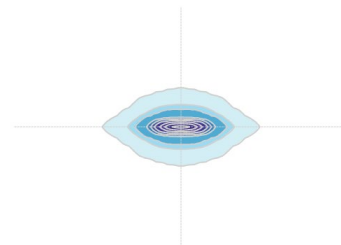
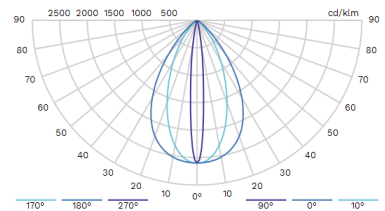

6298 - Circular Beam

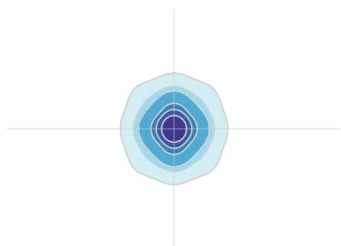
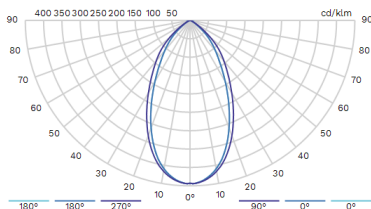

6316 - Circular Beam

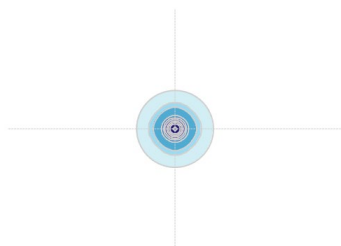
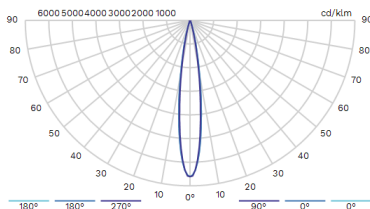

6318 - Elliptical, Vertical Beam

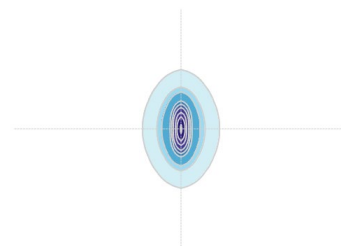
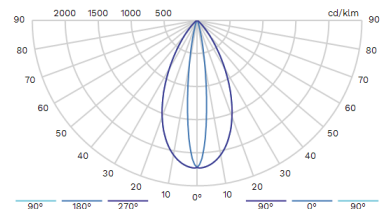

6322 - Elliptical, Vertical Beam

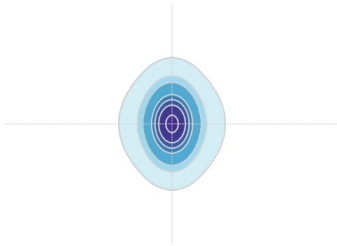
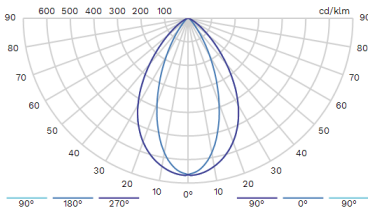

6323 - Elliptical, Vertical Beam

